



## ORIGINAL INSTRUCTIONS

---

## INTRODUCTION

---

This Belt and Disc Sander is for DIY and light workshop use for sanding wood and wood products.

Read the manual and follow the instructions carefully. In doing so you will ensure the safety of yourself and that of others around you, and you can look forward to your purchase giving you long and satisfactory service.

---

## GUARANTEE

---

This product is guaranteed against faulty manufacture for a period of 12 months from the date of purchase.

Please keep your receipt which will be required as proof of purchase.

This guarantee is invalid if the product is found to have been abused or tampered with in any way, or not used for the function for which it was intended.

Faulty goods must be returned to their place of purchase, no product can be returned to us without prior permission.

This guarantee does not effect your statutory rights.

---

## GENERAL SAFETY RULES

---



**WARNING: WHEN USING ELECTRIC TOOLS, BASIC SAFETY PRECAUTIONS MUST BE FOLLOWED TO DECREASE THE RISK OF FIRE, ELECTRIC SHOCK AND PERSONAL INJURY INCLUDING THE FOLLOWING. READ ALL THESE INSTRUCTIONS BEFORE ATTEMPTING TO OPERATE THIS PRODUCT AND SAVE THESE INSTRUCTIONS FOR FUTURE REFERENCE.**

---

### GENERAL SAFETY IN THE WORKPLACE

1. ALWAYS make sure that air can flow around the machine and that the air vents are clear.
2. ALWAYS keep work area clean & tidy. Cluttered work areas and benches invite accidents.
3. Do not over-reach. Keep proper footing and balance at all times.
4. Do not store equipment in a damp environment or expose to rain.

5. KEEP other persons away. Do not let persons, especially children, not involved in the work, touch the tool or extension cable and keep them away from the work area.
6. Do not operate a machine when under the influence of alcohol, drugs or medication.
7. ALWAYS ensure the workplace is well lit. Ensure that lighting is placed so that you will not be working in your own shadow.
8. Do not use tools in the presence of flammable liquids or gasses.
9. Stay alert, watch what you are doing, use common sense and do not operate the tool when you are tired.

## **CARE OF POWER TOOLS**

1. Read this manual carefully. Learn the machines applications and limitations, as well as the specific potential hazards peculiar to it.
2. ALWAYS keep guards in place and in working order. A guard or other part that is damaged should be properly repaired or replaced by an authorised service centre, unless otherwise indicated in this instruction manual.
3. Don't force the machine and use the correct tool. It will do the job better and safer, at the rate for which it was intended.
4. ALWAYS disconnect the machine from the power supply before carrying out any servicing or changing of accessories.
5. Before further use of the tool, it should be carefully checked to determine that it will operate properly and perform its intended function. Check for alignment of moving parts, binding of moving parts, breakage of parts, mounting or other condition that may affect its operation.
6. Have defective switches repaired by an authorised service centre. Do not use a tool if the switch does not turn it on and off.
7. ALWAYS check for any damage or any condition that could affect the operation of the machine. Damaged parts should be properly repaired.
8. Have your tool repaired by a qualified person. This tool complies with the relevant safety rules. Repairs should only be carried out by qualified persons using original spare parts, otherwise this may result in considerable danger to the user.
9. Do not use this product for any other purpose than that described in this booklet.
10. Do not abuse the power cable by yanking the cable to disconnect it from the socket. Keep the cable away from heat, oil or sharp edges.
11. Guard against electric shock. Avoid body contact with earthed or grounded surfaces.

12. If the machine should be used outdoors, use only extension cables intended for outdoor use and marked accordingly.
13. Avoid accidental starting by making sure the power switch is off before plugging in the power cable.

## **ADDITIONAL PRECAUTIONS FOR BELT & DISC SANDERS**

1. ALWAYS wear ear protectors/defenders when using this machine.
2. ALWAYS wear a dust mask when using this machine. Be aware of harmful or toxic dust produced when sanding some woods, paint, etc.
3. ALWAYS use the sanding belt support or table to support the workpiece.
4. Always check to ensure that the table, belt support and attachments are secure before starting.
5. ALWAYS maintain a clearance of 2.5-4 mm between the table and the sanding belt or disc.
6. ALWAYS hold the workpiece firmly so that it cannot be pulled from your hands.
7. ALWAYS feed the workpiece against the direction of rotation of the disc. i.e the LEFT side of the disc.
8. ALWAYS keep the mains cable well away from the machine and ensure an adequate electrical supply is close at hand so that the operation is not restricted by the length of the cable.
9. ALWAYS use a dust extraction device, properly connected to the dust extraction port.
10. ALWAYS ensure that nails or any foreign objects have been removed from a workpiece beforehand. Nails etc., will destroy the belt or disc.
11. NEVER allow the ventilation slots in the motor to become blocked.
12. NEVER sand pieces which cannot be held firmly by hand.





**WARNING: USE ONLY FOR SANDING WOOD. DO NOT USE FOR MATERIALS CONTAINING ASBESTOS, PAINTED SURFACES OR MATERIALS WHICH EMIT TOXIC PARTICLES.**

## **DUST EXTRACTION**

The sander is provided with a dust extraction facility. Please note however, that this does not preclude the user from wearing a face mask to prevent the inhalation of dust particles.

It is an EEC requirement that a dust extraction facility be provided on power tools, however, due to the nature of the sander, some of the dust produced will be forced into the surrounding atmosphere and will not be collected.

## SAFETY SYMBOLS

	Read this instruction booklet carefully.		Wear ear protection.
	Wear eye protection.		Wear a dust mask that is specially designed to filter microscopic particles.

## SPECIFICATION

Part Number	CBS125
Electrical Supply	230V 50Hz 1 ph
Fuse rating	5 Amp
Power	250W
Belt Size	25.4 x 762 mm
Diameter of Disc	125 mm / 5 inch
Table Size Belt	Ø 148 mm
Table Size Disc	184 x 98 mm
Dust Extraction Outlet	Inner diameter - 38mm / External diameter = 45mm
Overall L x W x H	360 x 300 x 395 mm
Weight	7.5 kg

# ELECTRICAL CONNECTIONS



**WARNING: READ THESE ELECTRICAL SAFETY INSTRUCTIONS FULLY BEFORE CONNECTING TO THE MAINS SUPPLY.**

Before switching the product on, make sure that the voltage of your electricity supply is the same as that indicated on the rating plate. This product is designed to operate on 230VAC 50Hz. Connecting it to any other power source may cause damage.

This product is provided with a standard 13 amp, 230 volt (50Hz), BS 1363 plug, for connection to a standard, domestic electrical supply. Should the plug need changing, make sure that a plug of identical specification is used.



**WARNING: THE WIRES IN THE CABLE ARE COLOURED AS FOLLOWS:  
BLUE = NEUTRAL    BROWN = LIVE    YELLOW AND GREEN = EARTH**

If the colours of the wires in the power cable do not correspond with the markings on the terminals of your plug, proceed as follows.

- Connect the **blue** wire to the terminal which is marked **N**.
- Connect the **brown** wire to the terminal which is marked **L**.
- Connect the **yellow and green** wire to the terminal which is marked **E** or  $\perp$ .

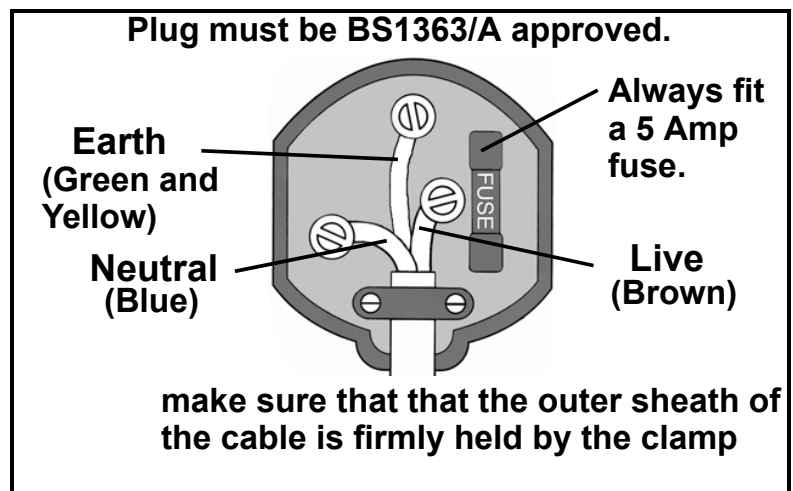

**WE STRONGLY RECOMMEND THAT THIS MACHINE IS CONNECTED TO THE MAINS SUPPLY VIA AN APPROVED RESIDUAL CURRENT DEVICE (RCD) WHICH HAS A TRIPPING CURRENT OF LESS THAN 30mA.**

If you are not sure, consult a qualified electrician. DO NOT try to do any repairs.

# ASSEMBLY

## SANDING BELT TABLE

1. Slide the belt into the slot on the table.
2. Position the table so that the machined slot below lines up with the hole in the casting.

3. Use the handle and washer supplied to fix the table into position.

**NOTE:** The distance between the belt and the table must be between 2.5-4 mm to prevent small pieces slipping down between the belt and table.

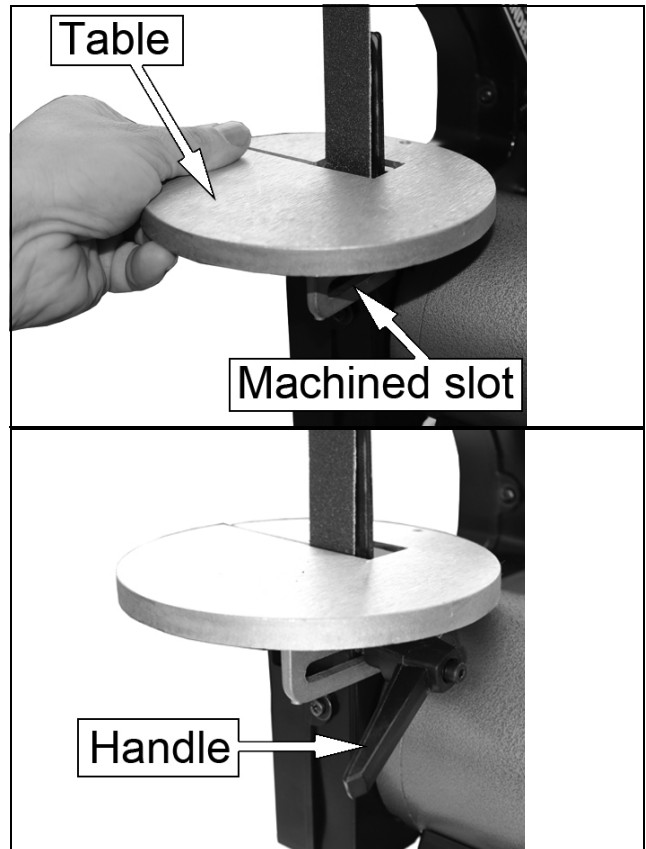

## DUST EXTRACTION MOULDING

1. Use a suitable screwdriver to remove the 3 screws and washers.
2. Place the dust extraction moulding into position.
3. Use the screws you removed in step 1 to fix into place.

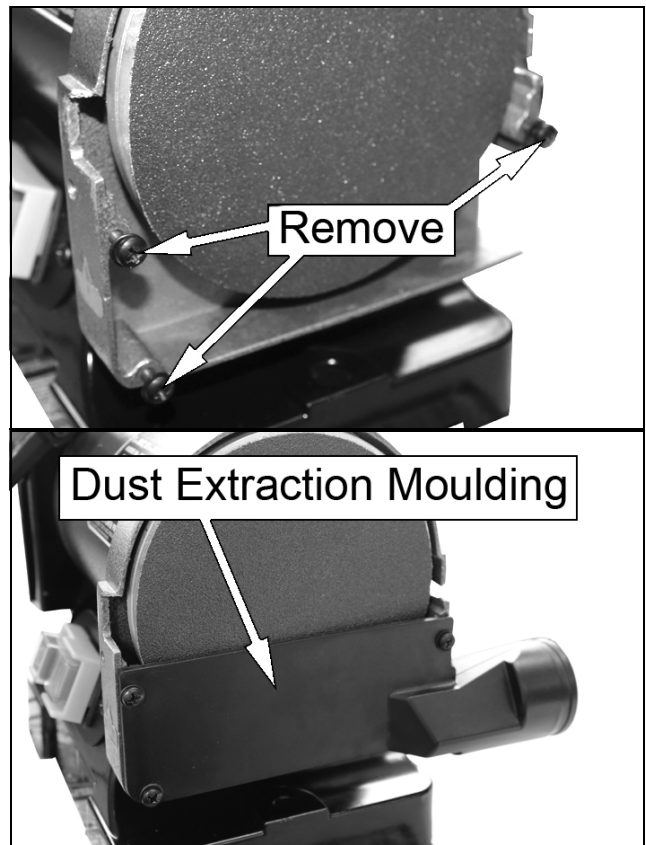

## SANDING DISC TABLE

1. Line up the table pins with the L shape slots on either side of the sanding disc, push the table in as far as possible.
2. Screw the locking handwheels through the machined slots into the pre-drilled hole until finger tight.

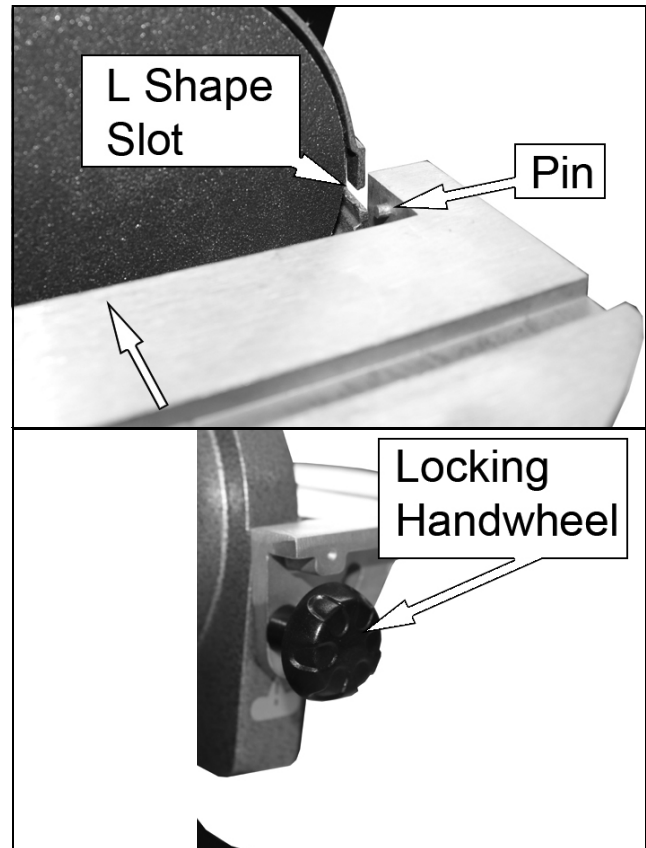

---

## ADJUSTMENTS BEFORE USE

---

### DISC TABLE ADJUSTMENT

1. Put an engineers square on the table and slacken the locking handwheels slightly.
2. Adjust the table so it is at right angles to the disc then tighten the locking handwheels.
3. If a different angle is necessary use an angle setting guage to guarentee precision.

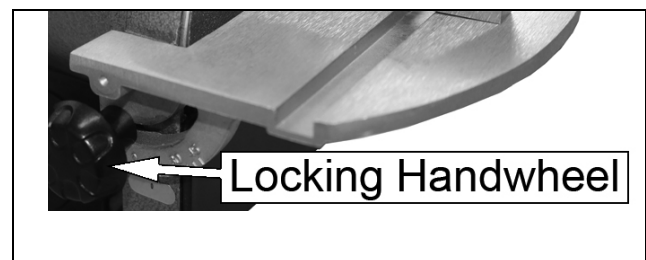



## MITRE FENCE ADJUSTMENT

1. Check the mitre fence is perpendicular to the disc and adjust if required.
2. Set the pointer on the mitre fence to 0° if required
  - Once the pointer is set, you can adjust the angle to whatever angle you need.

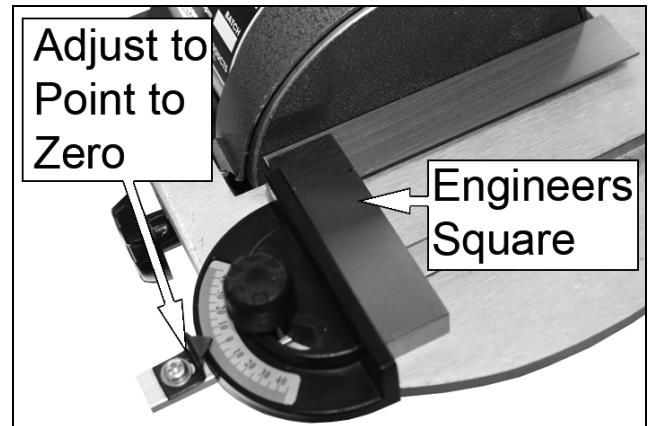

## BELT TABLE ADJUSTMENT

1. Loosen the handle.
2. Put an engineers square on the table touching the belt
3. Adjust the table until it is at right angles to the belt.
4. Tighten the handle.
5. For fine adjustments, adjust the grub screw located at the rear of the table. When correct, clamp the grub screw in position using the nut beneath the table.

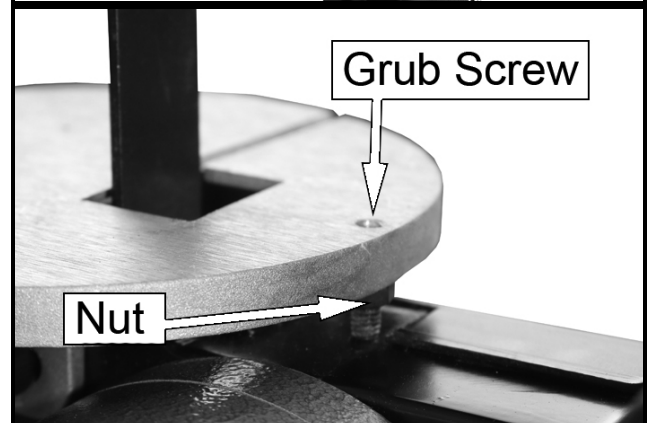
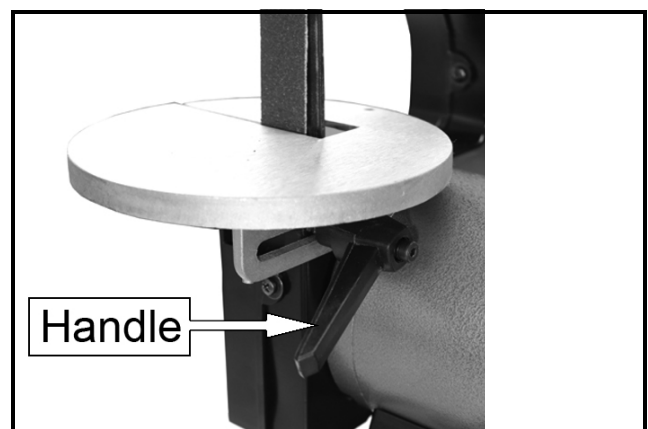

## BELT TRACKING

1. Remove the screws and clamping knob indicated.

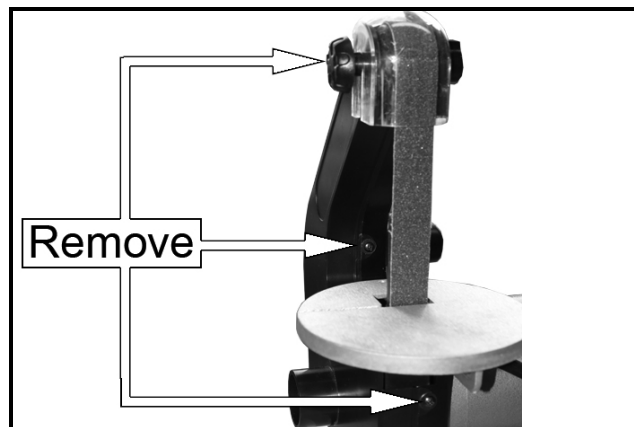

2. Remove the belt cover.



3. Turn the belt by hand and adjust the tracking knob until the belt is tracking correctly.
  - Clockwise to track the belt to the right.
  - Anti-clockwise to track the belt to the left,

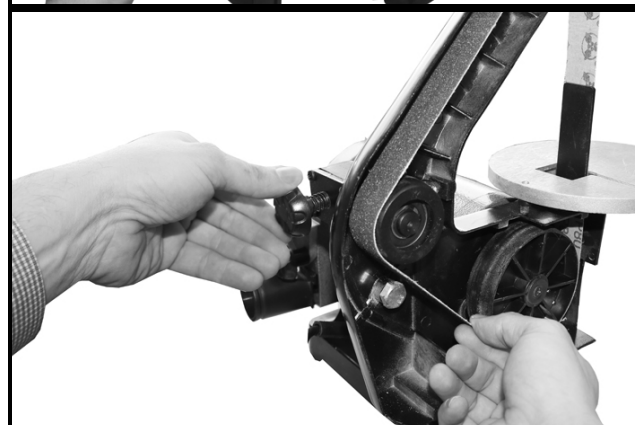

**NOTE:** You only need to make very small adjustments.

4. Replace cover screws and clamping knob.
5. Remove any tools from the sander and connect the sander to the power supply.
6. Push the START (I) button and let the sander reach full speed.
  - Check that the belt is tracking correctly, if not, press the stop button and disconnect the sander from the power supply. Then go back to step 1 and try again.
  - If everything is ok the sander is ready to use.

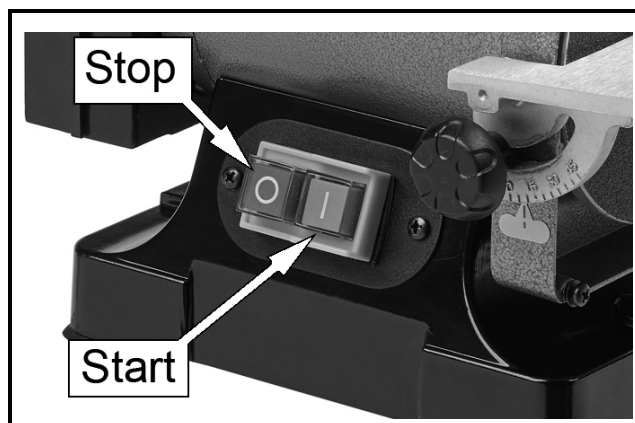

## OPERATION

**IMPORTANT:** Ensure that **ALL** components are secure, **ALL** correct adjustments have been carried out, and **ALL** safety precautions have been observed **BEFORE** plugging the machine into the mains supply and switching ON.

1. Attach a vacuum cleaner or other dust extraction device to the relevant extraction port.
2. Switch the machine ON by pressing the green START (I) button.
3. Make sure that the belt is tracking properly...adjust if necessary.
4. Holding the workpiece firmly, place it on the table and gently slide it into contact with the belt or disc. Do not force it, only a light pressure is required.

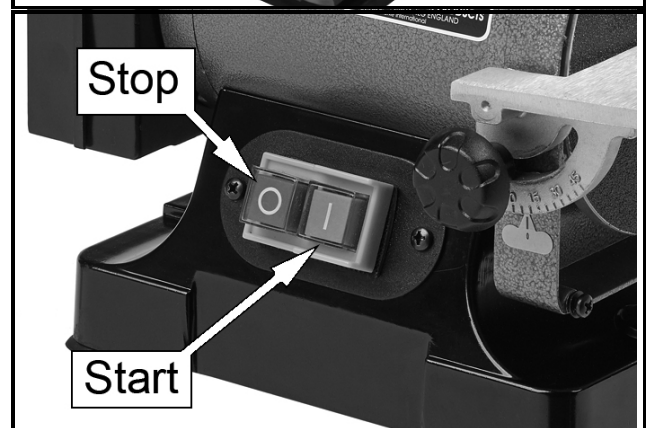
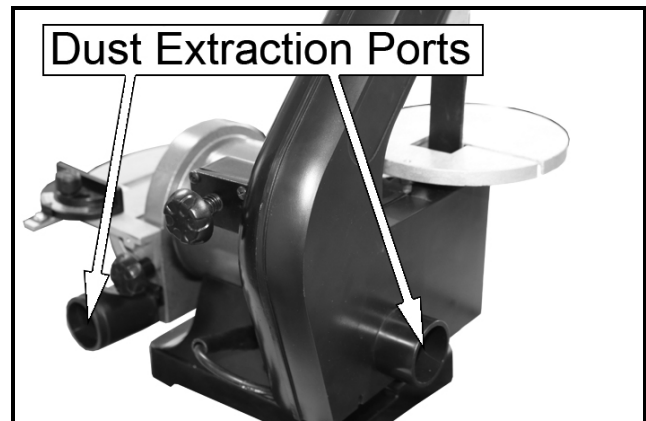

**IMPORTANT:** When using the sanding disc, **ALWAYS** use the left half of the disc **ONLY**, i.e. that side where the direction of rotation of the disc is down towards the table.

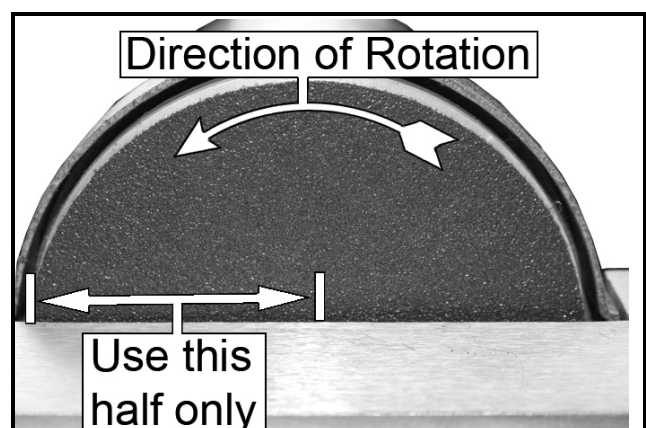

# MAINTENANCE

Always inspect the sander before use.

- Make sure that all air vents are clear.

Check the power cable to ensure it is sound and free from damage. Avoid using solvents when cleaning plastic parts, (most plastics are susceptible to damage from the various types of commercial solvents).

All bearings in this tool are lubricated for the machine's lifetime under normal operating conditions, therefore no further lubrication is required.

## CHANGING THE SANDING BELT

1. Remove the screws and clamping knob indicated

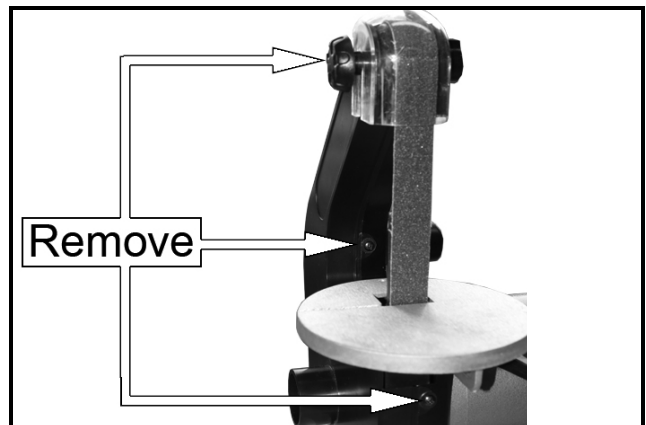

2. Remove the belt cover.

3. Replace the sanding belt ensuring it sits centrally on the rollers, and the arrow on the rear of the belt is pointing down towards the table.



4. Turn the belt by hand and adjust the tracking knob until the belt is tracking correctly.

- Clockwise to track the belt to the right
- Anti-clockwise to track the belt to the left,

5. Replace the cover screws and clamping knob.

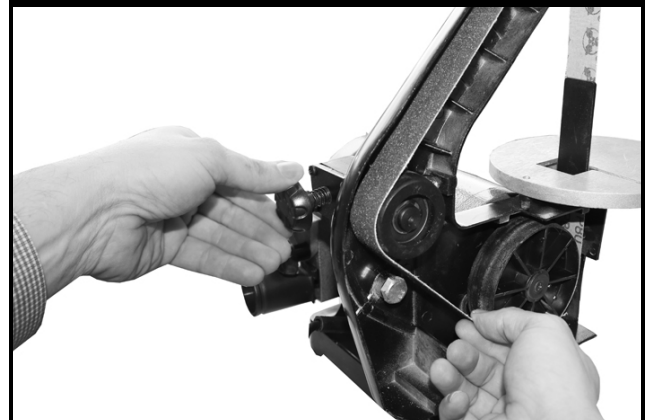

## **CHANGING THE DISC**

1. Remove the disc table and dust extraction moulding.
2. Using a sharp instrument, tease off a portion of the sanding disc, sufficient for it to be grasped by hand and peeled off.
3. Remove all residual adhesive and finally clean the disc with solvent.
4. Peel the backing from the replacement sanding disc and fix to the disc ensuring it is central. Press it firmly to ensure it is secure.
5. Replace the table and dust extraction moulding.

---

## **ENVIRONMENTAL RECYCLING POLICY**

---

Through purchase of this product, the customer is taking on the obligation to deal with the WEEE in accordance with the WEEE regulations in relation to the treatment, recycling & recovery and environmentally sound disposal of the WEEE.

In effect, this means that this product must not be disposed of with general household waste. It must be disposed of according to the laws governing Waste Electrical and Electronic Equipment (WEEE) at a recognised disposal facility.

---

# DECLARATION OF CONFORMITY

---



We Importer:

**TOOLSAVE LTD**

Unit C, Manders Ind. Est.,  
Old Heath Road, Wolverhampton,  
WV1 2RP.

Declare that the product:

**Designation: 1" BELT & 5" DISC SANDER**  
**Model: CBS125**

Complies with the following Directives:

Electromagnetic Compatibility Directive - **2004/108/EC**

Machine Directive - **2006/42/EC**

Restrictions of the use of Hazardous Substances in Electrical Equipment -  
**2011-65/EU** Waste Electrical and Electronic Equipment - **2012/19/EU**

Standards & technical specifications referred to:

**Authorized Technical File Holder: Bill Evans**

**24/05/2023**

**The Director**

A handwritten signature in black ink, appearing to read "Bill Evans".

